

**WARNING**



# PRECAUTION

- 1 The light can work as a dimmable light with 0-10V dimmer switch
- 2 Do not install on unstable ceiling surface to avoid falling-off.
- 3 The light cannot be covered by heat insulation pads or similar materials.
- 4 Before maintenance and installation, please confirm that the power supply has been and operated by a professional electrician.
- 5 The light will generate heat during operation. Do not use in high temperature and hum environment.
- 6 When the light doesn't work properly, be sure to cut off the power first and contact elfor a check.
- 7 Do not disassemble or modify the light by yourself to avoid danger.

## 3-Way Circuit

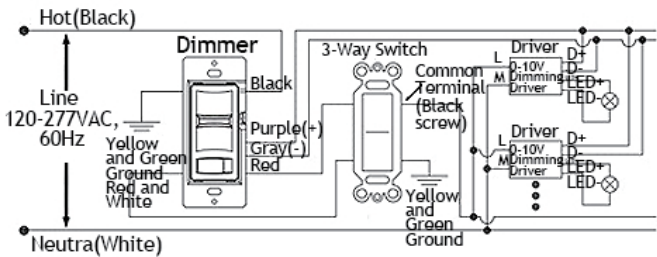
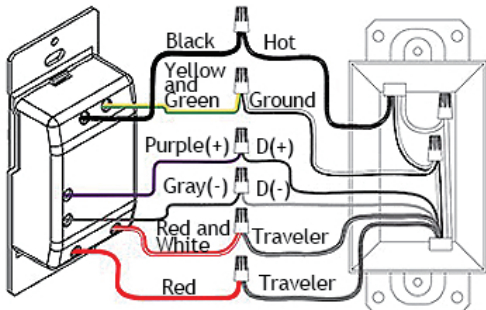

## Single Pole circuit

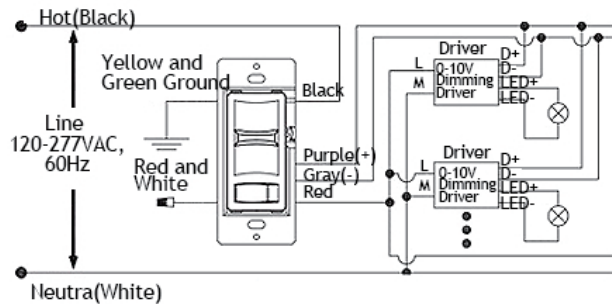
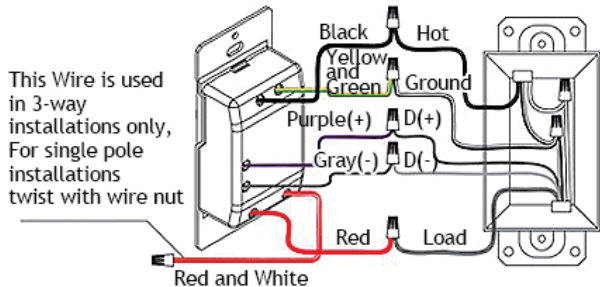

# Easy Installation

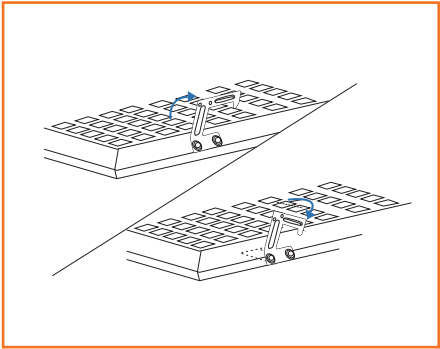

**STEP 1**

Stand up the protective bracket on the back of the panel light.

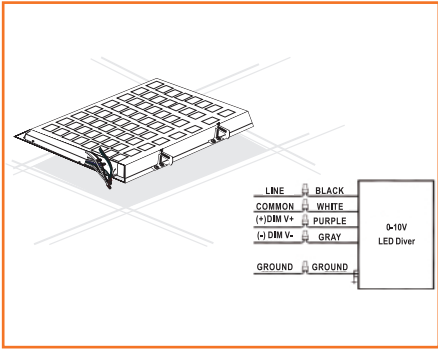

**STEP 2**

Open the junction box and connect the wires. Only suitable for 0-10V dimmer.

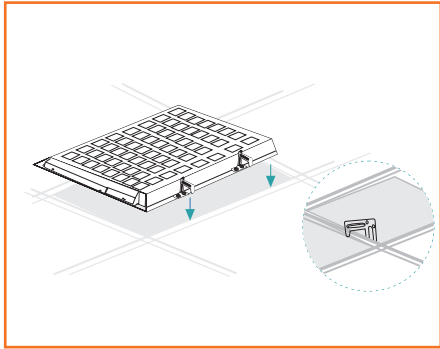

**STEP 3**

Install the LED panel light to the ceiling.



**2x4FT**

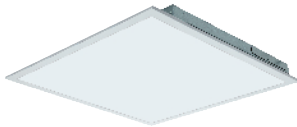

**2x2FT**



**1x4FT**

Size	2x4FT	2x2FT	1x4FT
Input Power	30/40/50W	20/30/40W	20/30/40W
Input Voltage	120-277V		
Luminous Efficiency	110 LM/W		
Color Temperature	3000K/4000K/5000K		
Material	Aluminum		
Color	White		
Switch	0-10V Dimmer		